

CAPS (TOP RAIL)

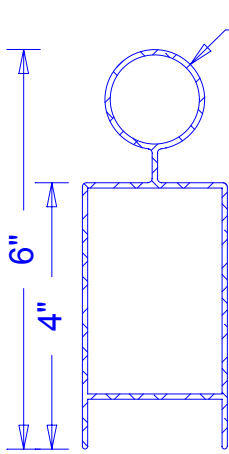

70

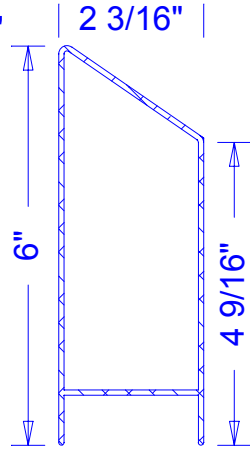

71

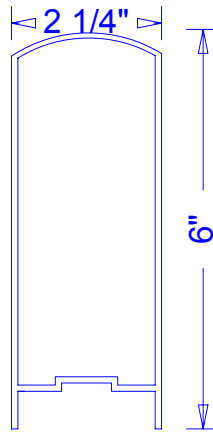

72

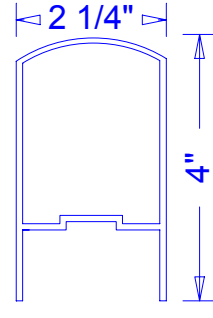

73

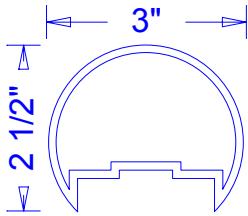

74

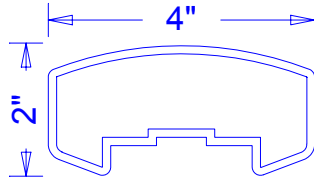

75

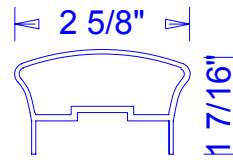

76

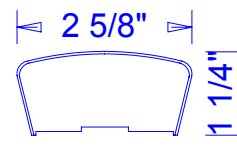

78

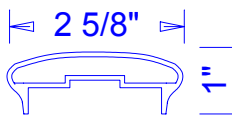

79

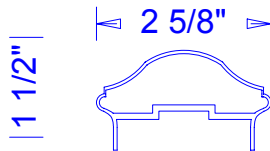

80



81

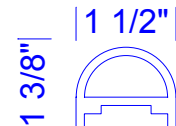

82

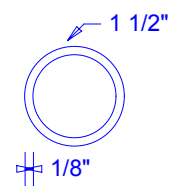
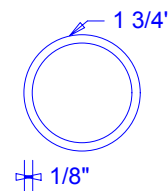
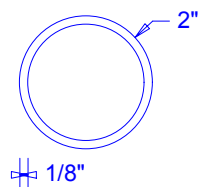
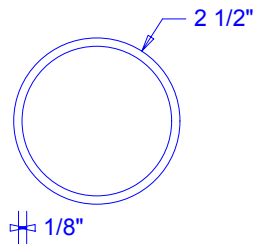
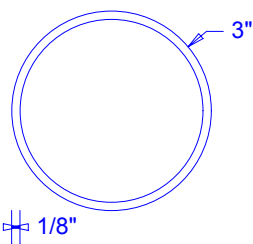
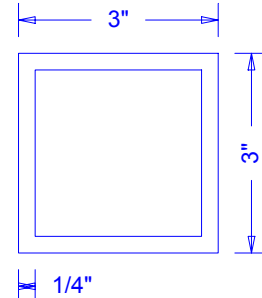
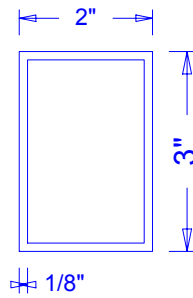
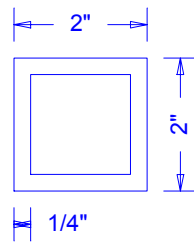
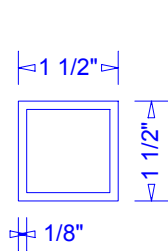

MIDDLE LINES

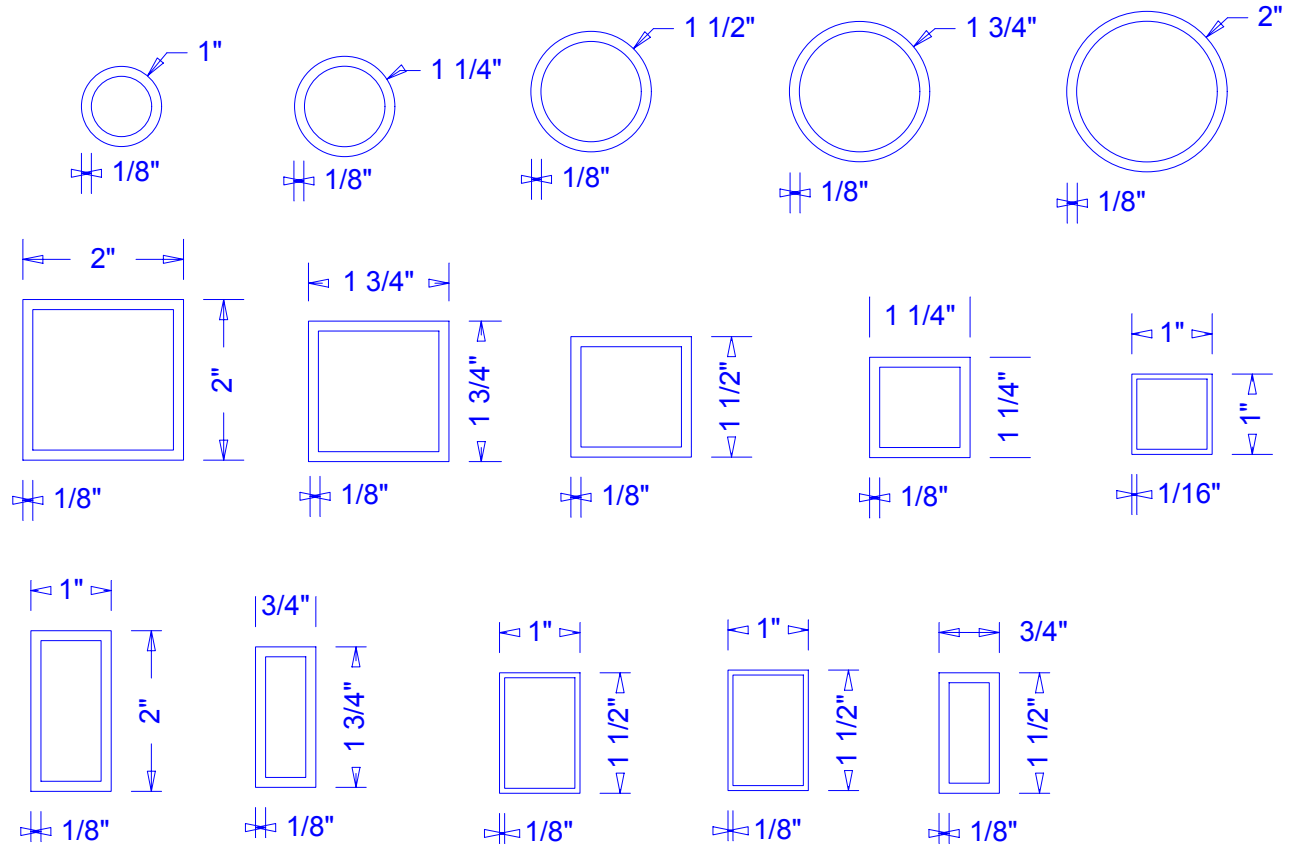

POSTS

